

## Artikel von A-Z/en



### Inhaltsverzeichnis





<b>1 V5</b> .....	1
<b>2 V7</b> .....	2
<b>3 V15</b> .....	2
<b>4 V21</b> .....	2
<b>5 Software</b> .....	2
5.1 <b>ETISS</b> .....	2
5.2 <b>ETISS NG</b> .....	3
5.3 <b>ETISS ERP</b> .....	3
5.4 <b>ETISS CWS</b> .....	3
5.5 <b>ETISS Canteen User Guide</b> .....	3
5.6 <b>ETOSS</b> .....	3
<b>6 Gate</b> .....	4
6.1 <b>Galaxy-Gate</b> .....	4
<b>7 Akku</b> .....	4
7.1 <b>Li-ion Battery</b> .....	4
<b>8 KT-Drive</b> .....	4
8.1 <b>KT Drive</b> .....	4
<b>9 POS</b> .....	4
9.1 <b>POS</b> .....	5
<b>10 Kamberi Group</b> .....	5
10.1 <b>Kamberi Group</b> .....	5

### Vending Unit





#### V5

- [VendingUnit ~ V5 ~ user manual](#)

	<p><b>V7</b></p> <ul style="list-style-type: none"> <li>■ <a href="#">VendingUnit ~ V7 ~ EasyGO ~ user manual</a></li> <li>■ <a href="#">VendingUnit ~ V7 ~ VU trolley ~ user manual</a></li> <li>■ <a href="#">VendingUnit ~ V7 ~ Bedienvideos</a></li> <li>■ <a href="#">VendingUnit ~ V7 ~ Softwareanleitung</a></li> <li>■ <a href="#">VendingUnit ~ V7 ~ Troubleshooting ~ Störung: Automat ist außer Betrieb</a></li> </ul>
	
	<p><b>V15</b></p> <ul style="list-style-type: none"> <li>■ <a href="#">VendingUnit ~ V15 ~ user manual</a></li> </ul>
	<p><b>V21</b></p> <ul style="list-style-type: none"> <li>■ <a href="#">VendingUnit ~ V21 ~ Prospekte</a></li> <li>■ <a href="#">VendingUnit ~ V21 ~ hopper management</a></li> <li>■ <a href="#">VendingUnit ~ V21 ~ Hoppermanagement</a></li> <li>■ <a href="#">VendingUnit/V21/Bedienvideos</a></li> </ul>

**Software**

	<p><b>ETISS</b></p> <ul style="list-style-type: none"> <li>■ <a href="#">ETISS ~ Informationsbroschüre</a></li> </ul>
-------------------------------------------------------------------------------------	-----------------------------------------------------------------------------------------------------------------------

	<p><b>ETISS NG</b></p> <hr/> <ul style="list-style-type: none"> <li>ETISS NG ~ Client Bedienungsanleitung</li> </ul>
	<p><b>ETISS ERP</b></p> <hr/> <ul style="list-style-type: none"> <li>Backend Frontend ~ ETISS ERP ~ Elektronischer Pförtner</li> <li>Backend Frontend ~ ETISS ERP ~ Lager Inventur</li> <li>Backend Frontend ~ ETISS ERP ~ Reporting</li> <li>Backend Frontend ~ ETISS ERP ~ Reporting v10</li> <li>Backend Frontend ~ ETISS ERP ~ Verkauf. Angebot anlegen</li> <li>ETISS ERP ~ Backend Bedienungsanleitung</li> <li>Backend Frontend ~ ETISS ERP ~ Datasheet</li> <li>ETISS ERP ~ POS Bedienungsanleitung</li> </ul>
	<p><b>ETISS CWS</b></p> <hr/> <ul style="list-style-type: none"> <li>ETISS CWS ~ Operation Manual</li> <li>ETISS CWS ~ User Guide</li> </ul>
	<p><b>ETISS Canteen User Guide</b></p> <hr/> <ul style="list-style-type: none"> <li>Articles from A-Z</li> <li>ETISS Canteen user Guide</li> </ul>
	<p><b>ETOSS</b></p> <hr/>

## Gate

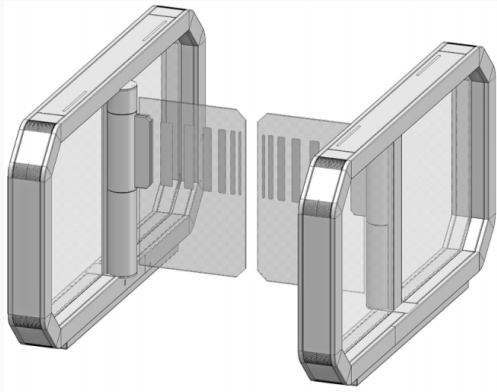

### Galaxy-Gate

- [Gate ~ FMCU Galaxy Gate ~ Prospekte](#)
- [Gate ~ FMCU Galaxy Gate ~ Access Manager](#)
- [Wanzl Access Manager ~ Management Dashboard](#)
- [Gate ~ FMCU Galaxy Gate ~ Operation Manual](#)
- [Gate ~ FMCU Galaxy Gate ~ User Guide](#)
- [Gate ~ Installation](#)

## Akku



### Li-ion Battery

- [Li-ion battery ~ batterypack ~ user manual](#)
- [Li-ion battery ~ inverter ~ user manual](#)
- [Li-ion Batterie ~ Wanzl-100l Ladegerät ~ Bedienungsanleitung](#)

## KT-Drive



### KT Drive

- [KT drive ~ user manual](#)

## POS

	<b>POS</b>
-----------------------------------------------------------------------------------	------------

<b>Kamberi Group</b>	
	<b>Kamberi Group</b> <ul style="list-style-type: none"><li>■ <a href="#">Group Workflows</a></li><li>■ <a href="#">Operating Manual</a></li><li>■ <a href="#">Workflow Videos</a></li></ul>