

People Counter Dashboard/en



Inhaltsverzeichnis

1 Prepare KBOX A-330-RPI	2
1.1 Download image	2
1.2 Copy image to the Micro SD Card	2
2 Setup XOVIS cameras	2
2.1 Add XOVIS cameras	2
2.2 Change camera credentials	3
2.3 Delete API cameras.	3
2.4 Additional field designations.	4
3 Setup Dashboards	4
3.1 Add Dashboard.	4
3.2 Change Dashboard credentials	6
3.3 Delete Dashboard.	7
4 Setup Executable Devices	7
4.1 Add Executable Devices	7
4.2 Change Executable Device credentials	8
4.3 Delete Executable Device	8
4.4 Additional field designations.	9
5 Setup Output Signals of Executable Device	9
5.1 Add Output Signals	9
5.2 Change Output Signals credentials	11
5.3 Delete Output Signals	11
6 Upload files to the server	11
6.1 Add Files.	11
6.2 Show uploaded image files.	12
6.3 Delete Files.	12
7 Users	12
7.1 Add a user	12
7.2 Change user credentials	13
7.3 Remove a user	14
8 Change browser configuration	14
8.1 Reload browser configuration.	14
9 Network	15
9.1 Network Setup.	15
10 Example configuration layout with access control unit	17

Prepare KBOX A-330-RPI

Download image

Version	Download Link
1.3.0.1	http://nas0.dnsalias.com:5000/sharing/wZzteL0s7

Copy image to the Micro SD Card

1. Download an image from the table above
2. Extract an archive
3. Use utility **HDDRawCopy1.10Portable** from the archive to copy the image on the Micro SD Card

Setup XOVIS cameras

Add XOVIS cameras

1. To add a new XOVIS camera, you firstly need to select the **Devices/ Geräte** tab.



2. Click on the **Add/ Hinzufügen** button.

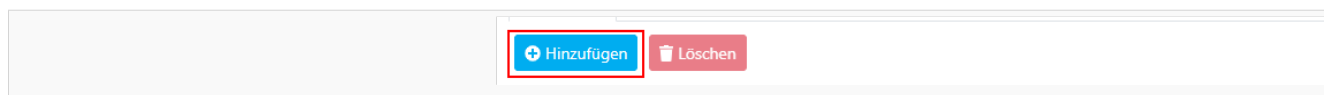

3. Here you should specify the camera URL.

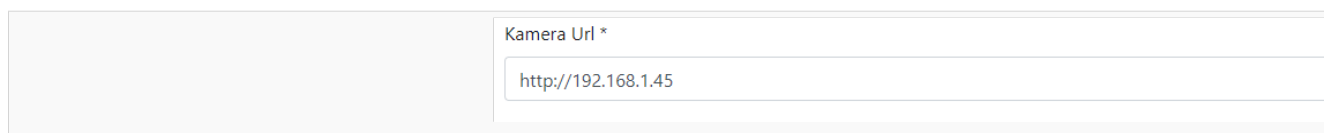
A screenshot of a form field labeled 'Kamera Url *'. The input field contains the text 'http://192.168.1.45'.

4. Specify a login to access the camera.

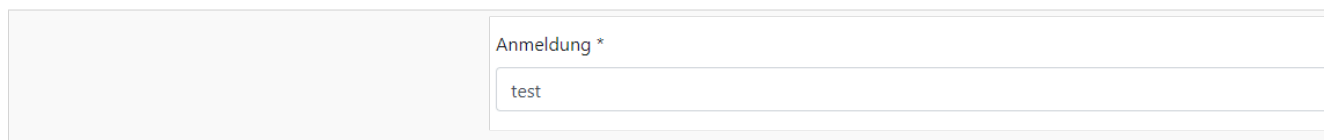
A screenshot of a form field labeled 'Anmeldung *'. The input field contains the text 'test'.

5. Specify a password to access the camera.

A screenshot of a form field labeled 'Passwort *'. The input field contains the text 'test'.

6. In this field specify the URL of your server (this field will be used for PUSH notification configuration on the camera side).

	Push-Server-Url *
	<input type="text" value="http://localhost:3030"/>

7. Save it.

	<input type="button" value="✓ Speichern"/> <input type="button" value="✗ Abbrechen"/>
--	---

Change camera credentials

1. If you want to change camera data just click on the camera list area.

	<input type="checkbox"/> Kamera Url
	<input type="checkbox"/> demo

2 Then click on the **Edit/ Bearbeiten** button.

	<input type="button" value="✎ Bearbeiten"/> <input type="button" value="🗑 Löschen"/>
--	--

3. After that you can change camera data.

4. And save changes.

	<input type="button" value="✓ Speichern"/> <input type="button" value="✗ Abbrechen"/>
--	---

Delete API cameras.

HINWEIS

Be careful! Do not remove cameras that are used.

1. To remove unwanted cameras, mark them.

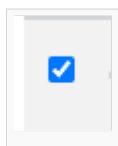

2. Click on the Delete/ Löschen button.

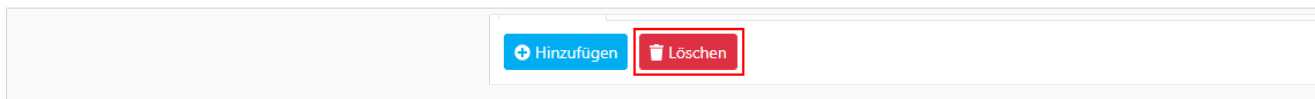

Additional field designations.

The status icon shows the connection to the camera. If it is green then the connection exists, if it is red then no connection exists.

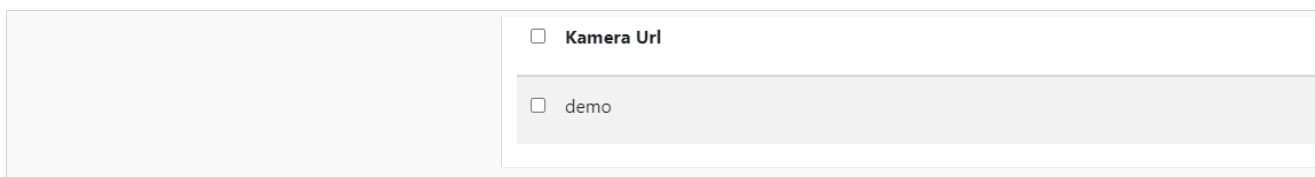

The status connection you can see also if you just click on the camera list area.

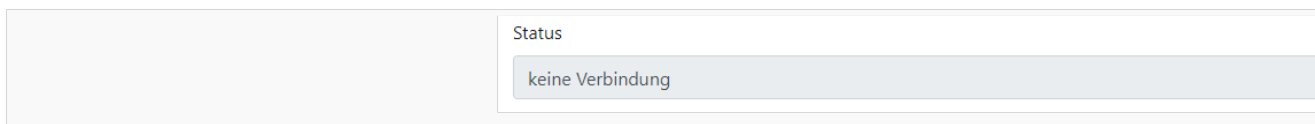

This field shows the connection error.

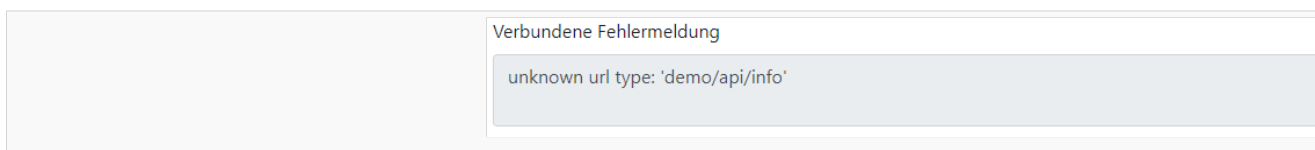

MAC camera address. It is automatically filled in by the server.

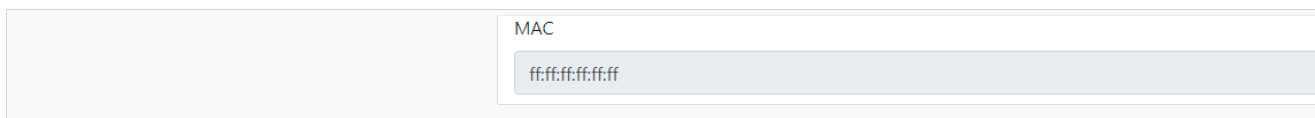

Setup Dashboards

Add Dashboard.

1. Add a new dashboard, you firstly need to go to Dashboard.



2. Select the Dashboards tab.

3. And then click on the **Add/ Hinzufügen** button.

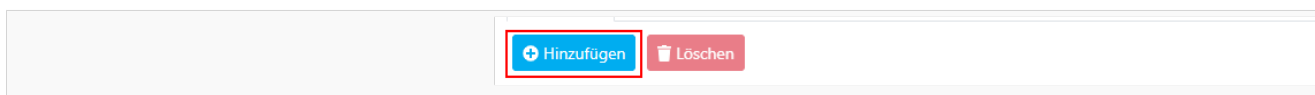

4. Enter here the name of the area.

	Name *
	Test

5. Here you should specify a unique name without spaces and starts with a lowercase letter. This is a service field. For example: If you specified the name "Test", you can specify a unique name "test".

	Eindeutiger Name *
	test

6. Here you can select a theme for the area display. For example:

	Vorlage
	Wählen Sie das Vorlage

7. Here you can choose the background for the "Basic" theme. If you want to add an image, you should upload it up to the server. More details on the link [upload files](#)

	Hintergrundbild
	background_wanzl.jpg

8. This field can be used in case if you want to specify an Offset for counter(for example when people are already in the area, but camera's counter is zero).

	Zähler-Offset
	0

9. Click on the **Add/ Hinzufügen** button to add a camera.

	Hinzufügen
--	----------------------------

10. Select the camera that was added earlier. If you do not know how to add a camera to click on this link [setup XOVIS cameras](#)

11. Choose the detect type.

12. Enter the name line.

	Kamera ▾	Typ erkennen ▾	Name der
	demo ▾	Line ▾	Line 0

13. Here we specify the maximum capacity of the number of people.

Kapazität *
10

14. Here you can specify the schedule restart counter time. If you need to specify more than 2 values, be sure to separate them with a semicolon.

Zeitplan für das Zurücksetzen des Zählers
06:00;18:00

If you need to change the text translation on Dashboard by interval:

15. To add the ability to select a language, click the **Add/ Hinzufügen** button as many times as you need the languages.

<input type="button" value="Hinzufügen"/>

16. Choose a language.

Sprachen ▾
English
Deutsch

17. Enter the language switching interval in seconds.

Sprach-Timeout(Sec)
10

18. And save it.

<input type="button" value="✓ Speichern"/> <input type="button" value="✗ Abbrechen"/>

Change Dashboard credentials

1. If you want to change dashboard data just click on the dashboard list area.

<input type="checkbox"/> Name
<input type="checkbox"/> Demo

2. Then click on the **Edit/ Bearbeiten** button.

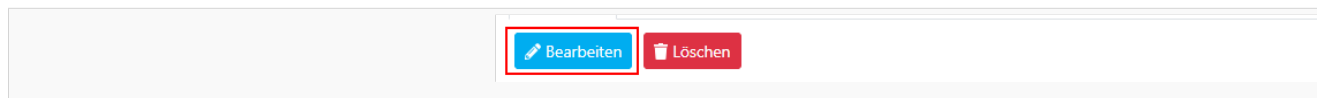

3. After that you can change dashboard data. 4. And save changes.

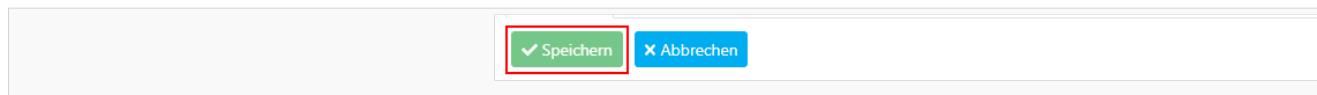

Delete Dashboard.

1. To remove unwanted Dashboard, mark them.

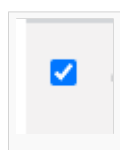

2. And then click on the **Delete/ Löschen** button.

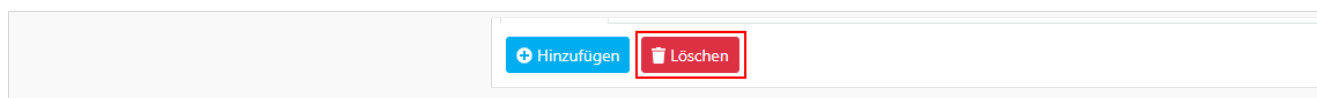

Setup Executable Devices

Add Executable Devices

1. To add a new executable device, you firstly need to select the **Devices/ Geräte** tab.



2. Select the **Executable Devices/ Ausführbare Geräte** tab.

3. And then click on the **Add/ Hinzufügen** button.

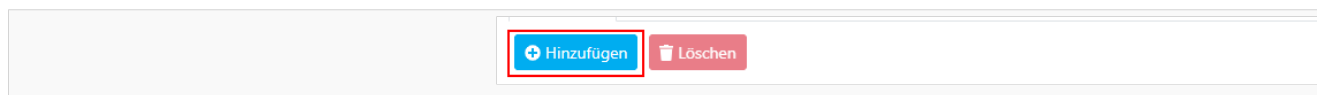

4. Select the type of executable device communication protocol.



5. Here you should specify the executable device URL.

	URL-Adresse *
	udp://192.168.1.10:12345

6. And Save it.

	<input type="button" value="✓ Speichern"/> <input type="button" value="✗ Abbrechen"/>
--	---

Change Executable Device credentials

1. If you want to change executable device data just click on the executable device list area.

	<input type="checkbox"/> Name
	<input type="checkbox"/> udp://192.168.1.10:12345

2. Then click on the **Edit/ Bearbeiten** button.

	<input type="button" value="✎ Bearbeiten"/> <input type="button" value="🗑 Löschen"/>
--	--

3. After that you can change executable device data.

4. And save changes.

	<input type="button" value="✓ Speichern"/> <input type="button" value="✗ Abbrechen"/>
--	---

Delete Executable Device

1. To remove an executable device, mark them.

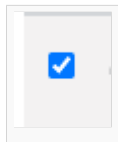

2. Be careful! Do not remove an executable device that is used. Click on the **Delete/ Löschen** button.

	<input type="button" value="➕ Hinzufügen"/> <input type="button" value="🗑 Löschen"/>
--	--

Additional field designations.

Command Information/ Kommando-Informationen contains information about commands to control the device.

Kommando-Informationen

- FF0100 - Relay 1 OFF command (ASCII encoding)
- FF0101 - Relay 1 ON command (ASCII encoding)
- FF0200 - Relay 2 OFF command (ASCII encoding)
- FF0201 - Relay 2 ON command (ASCII encoding)
- FF0300 - Relay 3 OFF command (ASCII encoding)
- FF0301 - Relay 3 ON command (ASCII encoding)
- FF0400 - Relay 4 OFF command (ASCII encoding)
- FF0401 - Relay 4 ON command (ASCII encoding)
- FFE000 - All relays OFF command (ASCII encoding)
- FFE003 - All relays ON command (ASCII encoding)

Setup Output Signals of Executable Device

Add Output Signals

1. To add new output signals, you firstly need to select the **Devices/ Geräte** tab.



The screenshot shows a navigation bar with the 'wanzi' logo on the left and four tabs: 'Zuhause', 'Geräte', 'Dashboard', and 'System'. The 'Geräte' tab is highlighted with a red box.

2. Select the **Output Signals/ Ausgangssignale** tab.

3. And then to click on the **Add/ Hinzufügen** button.

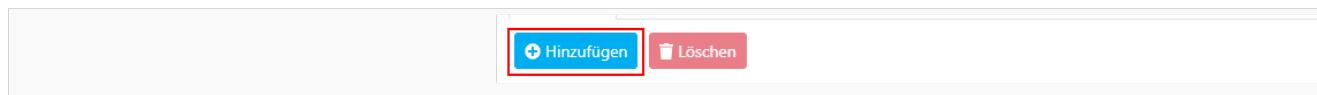

The screenshot shows two buttons: a blue button with a plus sign and the text 'Hinzufügen', and a red button with a trash icon and the text 'Löschen'. The 'Hinzufügen' button is highlighted with a red box.

4. Enter here the name of the output signals.

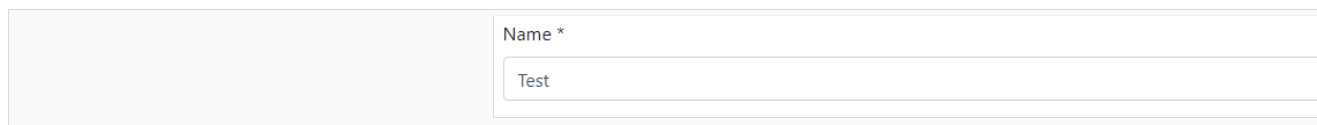

The screenshot shows a form with a label 'Name *' and an input field containing the text 'Test'.

5. Here you should select an area.

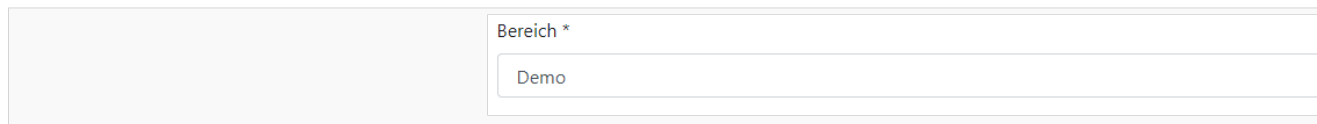

The screenshot shows a form with a label 'Bereich *' and an input field containing the text 'Demo'.

6. Here you should choose the executable device URL.

	Ausführbare Gerät *
	udp://192.168.1.10:12345

7. Insert the command of a high level of the executable device.

	Hochrangiger Befehl ⓘ
	FF0101

8. Insert the command of a low level of the executable device.

	Befehl auf niedriger Ebene ⓘ
	FF0100

9. Here you can specify transition delay time.

	Impulszeit, ms
	0

10. This field is necessary to specify the condition of relay triggering.

	Bedingung *
	capacity <= count

Information about Variables

Informationen zu Variablen	
Variablen	Informationen
capacity	Kapazitäts-Dashboard
availableSeats	Anzahl der verfügbaren Plätze
backgroundImage	Hintergrundbild-URL
peopleNumber	Anzahl der Personen in der Prämisse
offsetCount	Korrektur der Anzahl der Personen in der Prämisse
inCount	Anzahl der eingegebenen Personen
outCount	Anzahl der Ausstiegspersonen

[Schließen](#)

11. Save it.

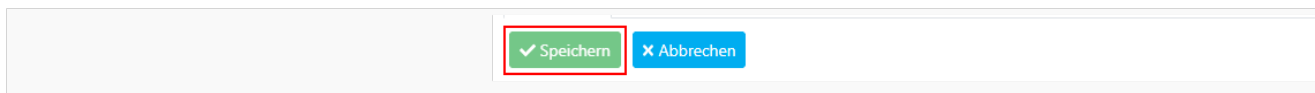

A screenshot of a form with two buttons at the bottom right: a green button with a checkmark and the text 'Speichern' (Save), and a blue button with an 'X' and the text 'Abbrechen' (Cancel). The 'Speichern' button is highlighted with a red rectangular box.

Change Output Signals credentials

1. If you want to change output signals data just click on the output signals list area.

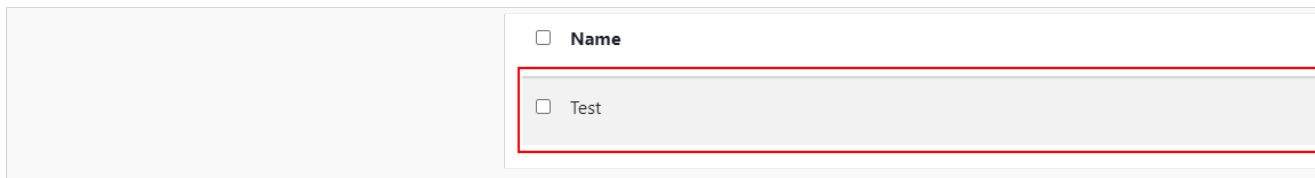

A screenshot of a list area. On the right side, there is a header 'Name' with a checkbox to its left. Below the header, there is a single entry 'Test' with a checkbox to its left. The entire list area is highlighted with a red rectangular box.

2. Then click on the **Edit/ Bearbeiten** button.

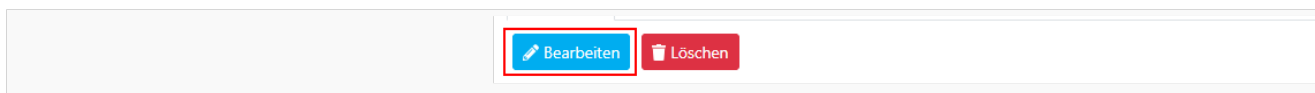

A screenshot of a form with two buttons at the bottom right: a blue button with a pencil icon and the text 'Bearbeiten' (Edit), and a red button with a trash can icon and the text 'Löschen' (Delete). The 'Bearbeiten' button is highlighted with a red rectangular box.

3. After that you can change its data.

4. And save changes.

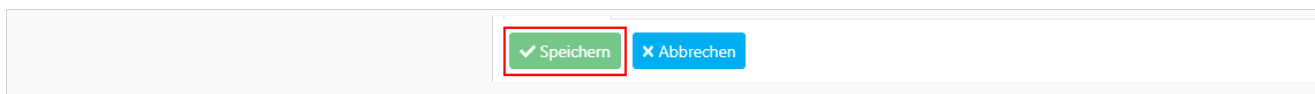

A screenshot of a form with two buttons at the bottom right: a green button with a checkmark and the text 'Speichern' (Save), and a blue button with an 'X' and the text 'Abbrechen' (Cancel). The 'Speichern' button is highlighted with a red rectangular box.

Delete Output Signals

1. To remove unwanted Output Signals, mark them.

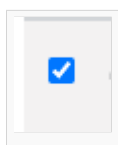

A screenshot of a checkbox that has been checked, indicated by a blue checkmark inside the box.

2. Click on the **Delete/ Löschen** button.

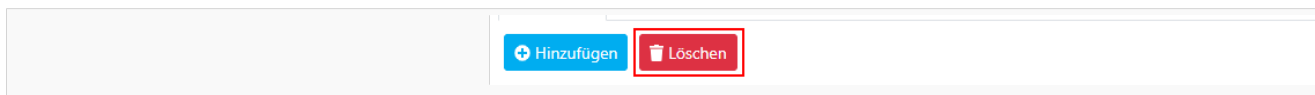

A screenshot of a form with two buttons at the bottom right: a blue button with a plus icon and the text 'Hinzufügen' (Add), and a red button with a trash can icon and the text 'Löschen' (Delete). The 'Löschen' button is highlighted with a red rectangular box.

Upload files to the server

Add Files.

1. Add a new area, you firstly need to go to Dashboard.



A screenshot of a navigation bar. It features the 'wanzi' logo on the left, followed by the text 'Zuhause Geräte' and 'System'. The 'Dashboard' text is highlighted with a red rectangular box.

2. Select the **Image Assets/ Bild-Assets** tab.

3. And then click on the **Add/ Hinzufügen** button and select a file on your file system. If a file is uploaded to the server, you can see it in the file list.

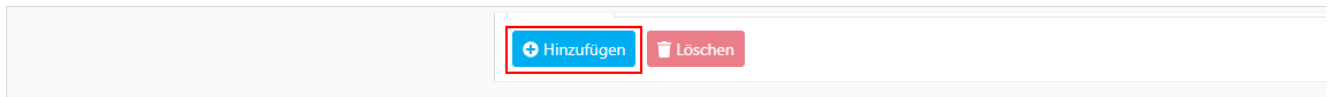

Show uploaded image files.

1. If you want to see image files just click on the file list area.

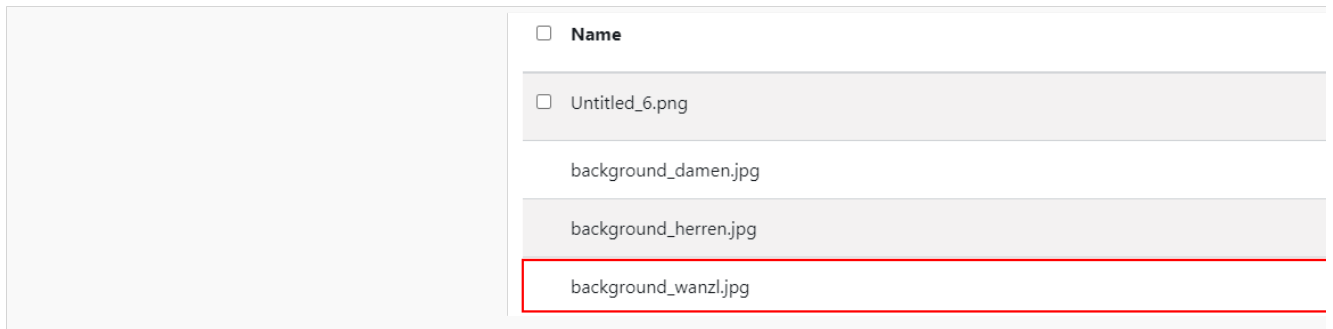

Delete Files.

HINWEIS

Be careful! Do not remove files that are used.

1. To remove unwanted files on the server, mark them. Preset files can't be deleted.

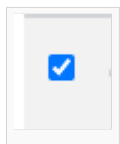

2. And then click on the **Delete/ Löschen** button.

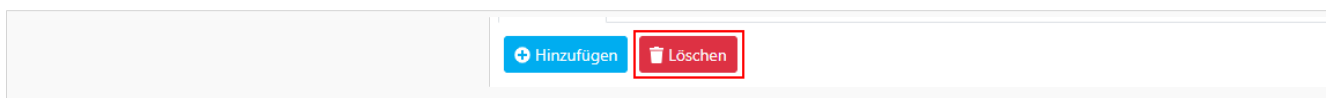

Users

Add a user

1. To add a new user, you firstly need to select the System tab.



2. Click on the **Users/ Benutzer** tab.

3. Then click on the **Add/ Hinzufügen** button.

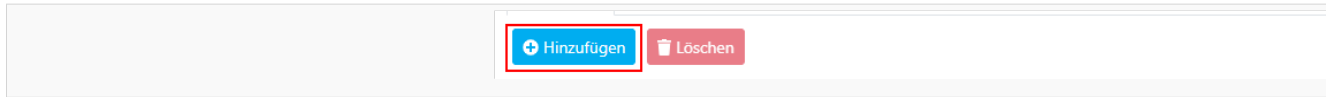

A screenshot of a user management interface. At the top right, there are two buttons: a blue button with a plus icon and the text 'Hinzufügen' (highlighted with a red box), and a red button with a trash icon and the text 'Löschen'.

4. In this field you should specify **Login/ Anmeldung** for a new user

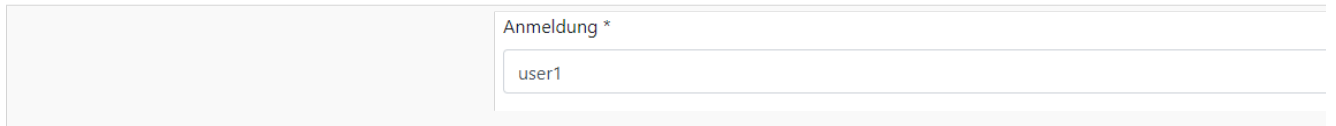

A screenshot of a user management interface. It shows a form with a label 'Anmeldung *' and a text input field containing the value 'user1'.

5. In this field you should specify **Password/ Passwort** for a new user

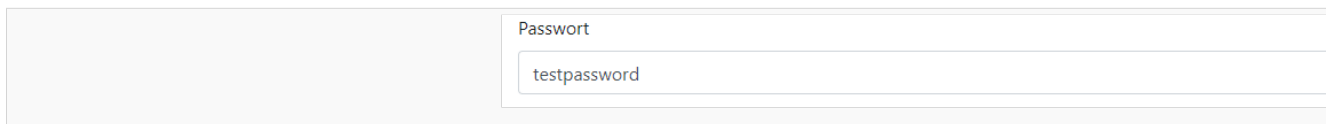

A screenshot of a user management interface. It shows a form with a label 'Passwort' and a text input field containing the value 'testpassword'.

6. If you want to grant the user administrator rights, tick this field. (Administrative rights give rights to edit, create, delete and view. And the standard rights only to view.)

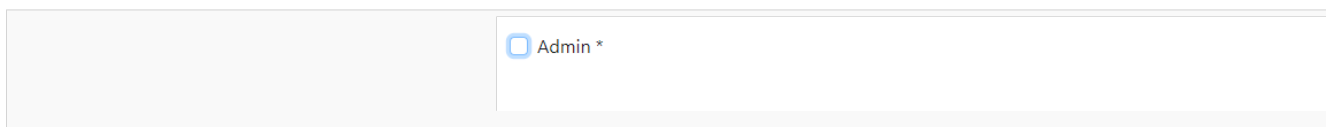

A screenshot of a user management interface. It shows a form with a label 'Admin *' and an unchecked checkbox.

7. Click on the **Save/ Speichern** button to complete the adding of a new user.

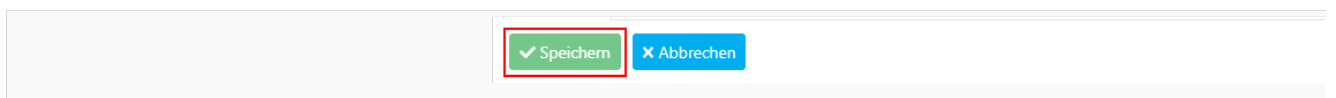

A screenshot of a user management interface. At the bottom right, there are two buttons: a green button with a checkmark icon and the text 'Speichern' (highlighted with a red box), and a blue button with an 'X' icon and the text 'Abbrechen'.

Change user credentials

1. If you want to change user data just click on the user list area.

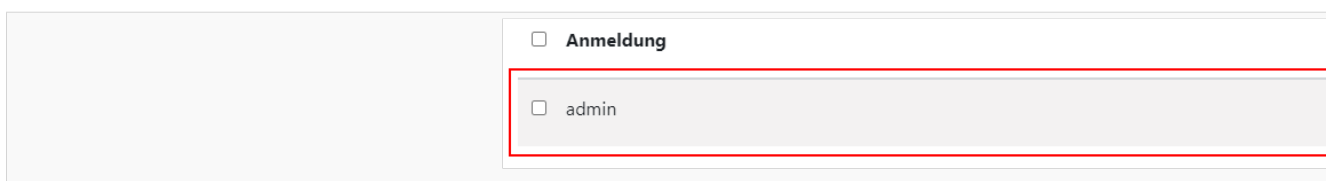

A screenshot of a user management interface. It shows a list of users with a header row containing a checkbox and the label 'Anmeldung', and a data row containing a checkbox and the value 'admin'. The data row is highlighted with a red box.

2. Then click on the **Edit/ Bearbeiten** button.

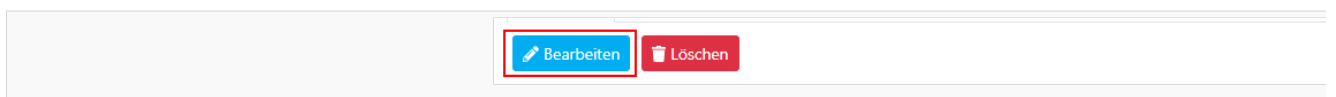

A screenshot of a user management interface. At the bottom right, there are two buttons: a blue button with a pencil icon and the text 'Bearbeiten' (highlighted with a red box), and a red button with a trash icon and the text 'Löschen'.

3. After that you can change user data. 4. And save the changes.

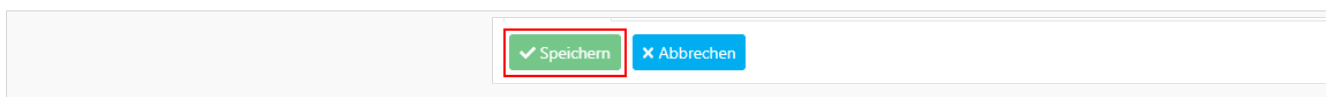

A screenshot of a user management interface. At the bottom right, there are two buttons: a green button with a checkmark icon and the text 'Speichern' (highlighted with a red box), and a blue button with an 'X' icon and the text 'Abbrechen'.

Remove a user

HINWEIS

Be careful! Do not remove users that are used.

1. To remove unwanted user, mark them. Preset files can't be deleted.

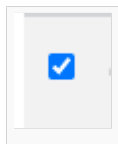

2. And then click on the **Delete/ Löschen** button.

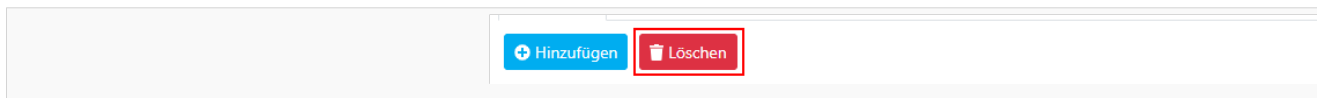

Change browser configuration

Reload browser configuration.

1. To display, you firstly need to go to **System**.



2. Select the **Display/ Bildschirm** tab.

3. If you need a mouse cursor to be displayed in the kiosk, tip this field.

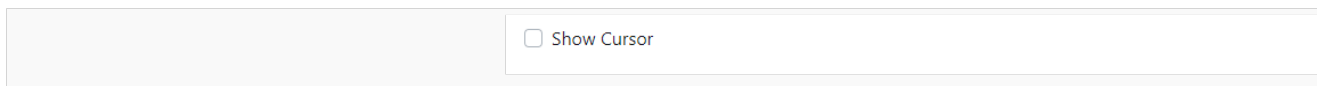

4. Enter the display URL.

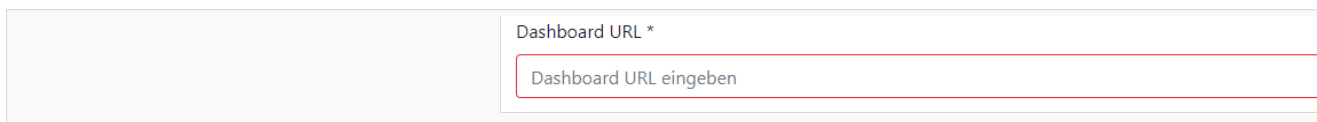

5. Click on the **Save** button.

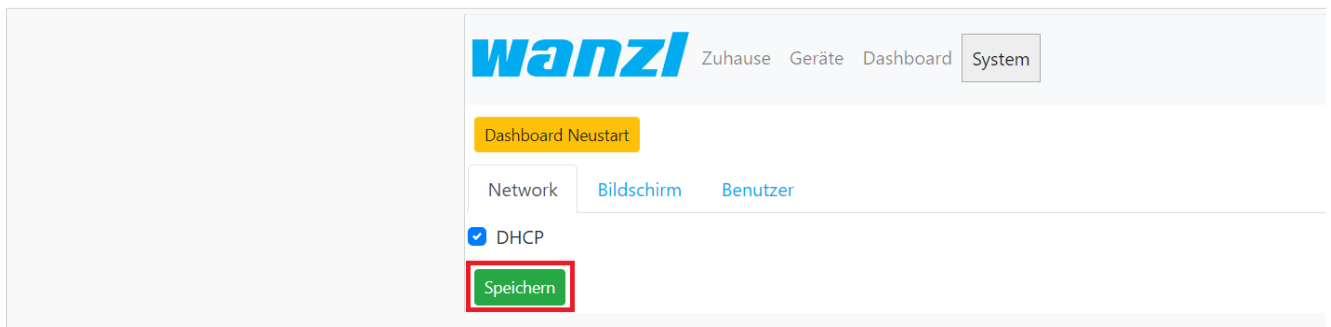

6. Then click on the **Reboot** button.

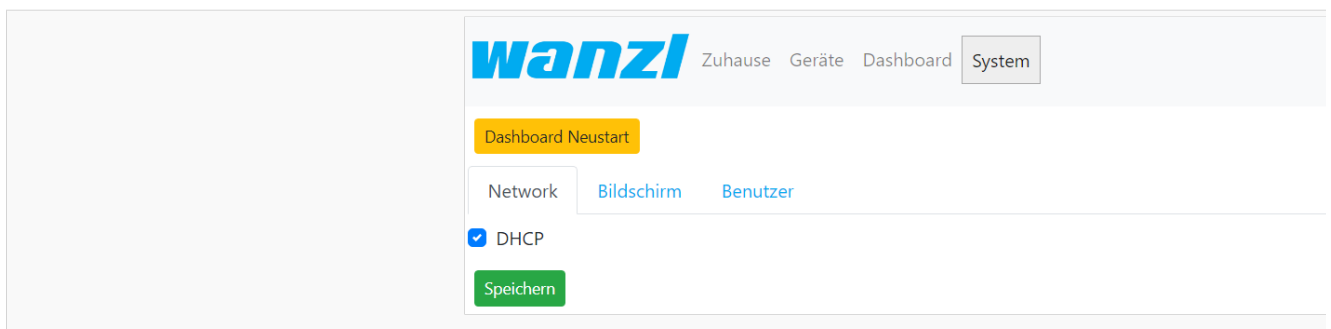

Network

Network Setup.

1. To configure or view the network settings, you firstly need to go to **System**.



2. Select the **Network** tab.

There are two methods of network configuration.

The first method:

- Tip the field.

DHCP

- Click on the **Save** button.

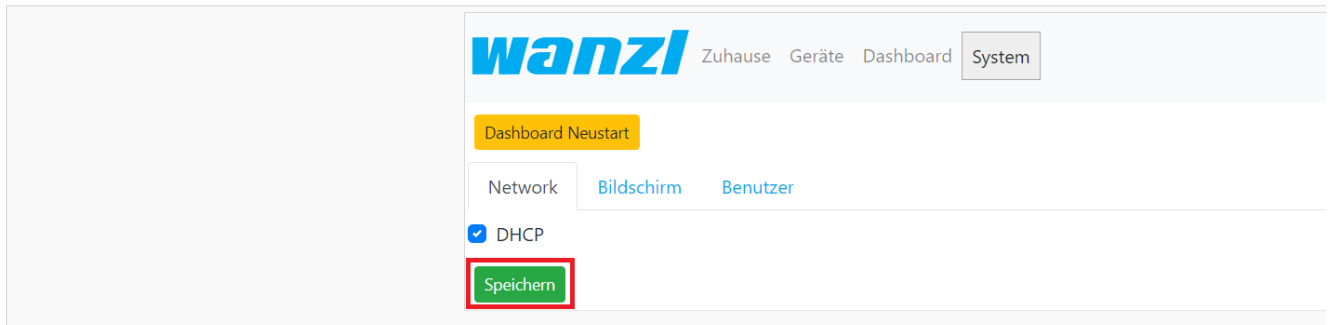

wanzi Zuhause Geräte Dashboard System

Dashboard Neustart

Network Bildschirm Benutzer

DHCP

Speichern

- Then click **Reboot** button. And the DHCP server will automatically give the necessary settings.

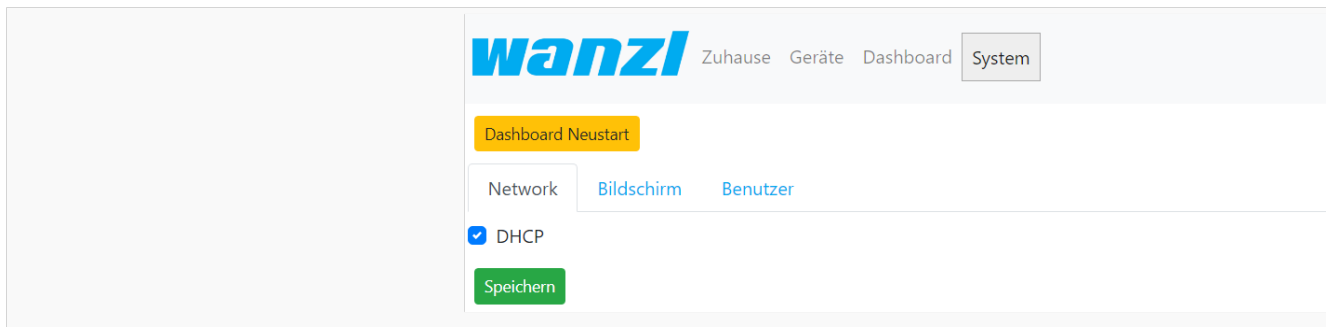

wanzi Zuhause Geräte Dashboard System

Dashboard Neustart

Network Bildschirm Benutzer

DHCP

Speichern

The second method:

- Specify an IP address.

Address *

192.168.1.66

- Enter netmask.

Netmask *

255.255.255.0

- Input address of the gateway.

Gateway *

192.168.1.1

People Counter Dashboard/en

- Now fill in the DNS IP address.

	DNS Server *
	<input type="text" value="8.8.8.8"/>

- And then click on the *Reload* button.

<input type="button" value="Reload"/>

Example configuration layout with access control unit

Configure external device ([KMTronic Herstellerinformation](#))

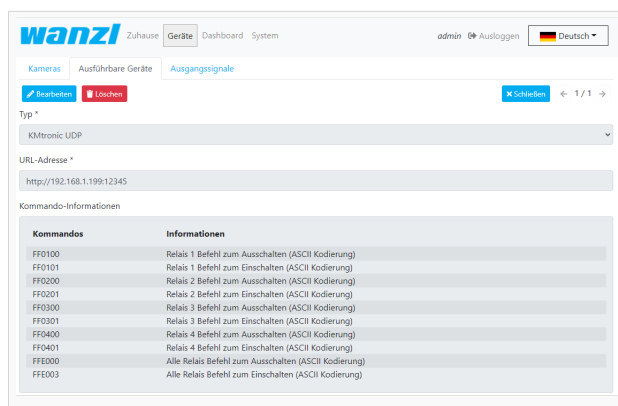

Kommandos	Informationen
FF0100	Relais 1 Befehl zum Ausschalten (ASCII Kodierung)
FF0101	Relais 1 Befehl zum Einschalten (ASCII Kodierung)
FF0200	Relais 2 Befehl zum Ausschalten (ASCII Kodierung)
FF0201	Relais 2 Befehl zum Einschalten (ASCII Kodierung)
FF0300	Relais 3 Befehl zum Ausschalten (ASCII Kodierung)
FF0301	Relais 3 Befehl zum Einschalten (ASCII Kodierung)
FF0400	Relais 4 Befehl zum Ausschalten (ASCII Kodierung)
FF0401	Relais 4 Befehl zum Einschalten (ASCII Kodierung)
FF0000	Alle Relais Befehl zum Ausschalten (ASCII Kodierung)
FF0003	Alle Relais Befehl zum Einschalten (ASCII Kodierung)

The default configuration can be reviewed on the homepage of the producer.

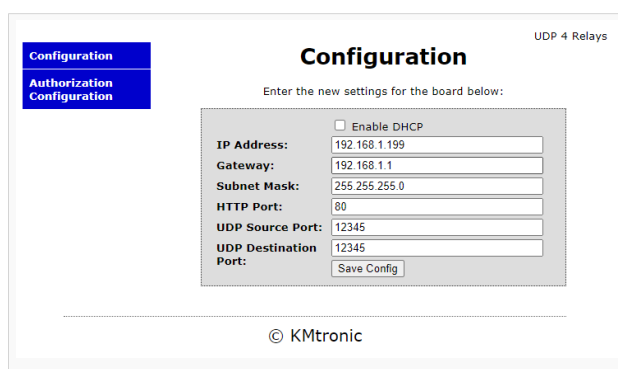

Configuration

UDP 4 Relays

Enter the new settings for the board below:

IP Address:	<input type="checkbox"/> Enable DHCP
Gateway:	<input type="text" value="192.168.1.199"/>
Subnet Mask:	<input type="text" value="192.168.1.1"/>
HTTP Port:	<input type="text" value="255.255.255.0"/>
UDP Source Port:	<input type="text" value="80"/>
UDP Destination Port:	<input type="text" value="12345"/>
	<input type="text" value="12345"/>
	<input type="button" value="Save Config"/>

© KMtronic

There are a total of 4 relays for this external device, each with a normally open / normally closed contact. In the Output signals tab, you can now select a relay that will be used as a switch for access control.

People Counter Dashboard/en

In this configuration, relay 1 is used as a switching contact in the signal definition. A pulse length of 0 ms is defined, which means it is an on / off switch. In this configuration, the switching pulse is set when the actual number of people is greater than the set maximum capacity.

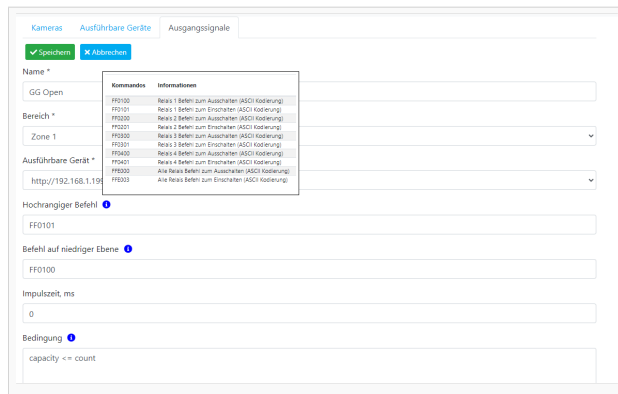

Name *	Kommandos	Informationen
GG Open	FF0100	Relais 1 Beten zum Ausschalten (ASCII Kodierung)
	FF0101	Relais 1 Beten zum Einschalten (ASCII Kodierung)
Bereich *	FF0200	Relais 2 Beten zum Ausschalten (ASCII Kodierung)
	FF0201	Relais 2 Beten zum Einschalten (ASCII Kodierung)
Zone 1	FF0300	Relais 3 Beten zum Ausschalten (ASCII Kodierung)
	FF0301	Relais 3 Beten zum Einschalten (ASCII Kodierung)
Ausführbare Gerät *	FF0400	Relais 4 Beten zum Ausschalten (ASCII Kodierung)
	FF0401	Relais 4 Beten zum Einschalten (ASCII Kodierung)
	FF0500	Acht Relais Beten zum Ausschalten (ASCII Kodierung)
	FF0501	Acht Relais Beten zum Einschalten (ASCII Kodierung)

Hochrangiger Befehl: FF0101

Befehl auf niedriger Ebene: FF0100

Impulszeit, ms: 0

Bedingung: capacity <= count

The technical connection overview is shown in this illustration. The signal lines are connected as NO (Normal Open) to contact U2 E7 on the connection board. This means that if the maximum capacity is exceeded, the access control is blocked.

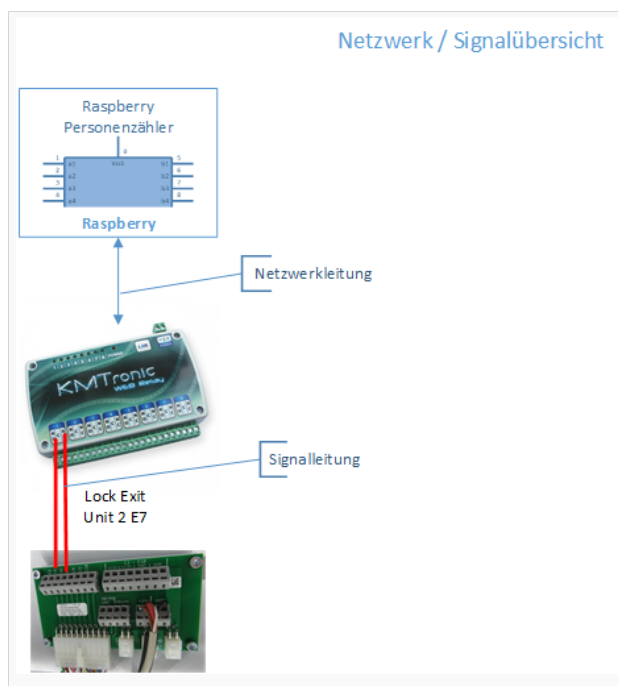

If necessary, several switching contacts can be used according to the technical requirements.